

PWS6300

Installation and Operation manual

1 PWS6300 Installation

1.1 Introduction

PWS6300 is a Human Machine Interface (HMI) with a 3" STN Liquid Crystal Display, and is water- and dust-resistant according to IP65/NEMA4.

The HMI is CE-marked and meets your need to be highly transient-resistant while in operation.

Also, its compact design makes connections with other machinery more flexible, thus achieving the optimal performance of your machines.

ADP is used to design applications of the HMI; it is reliable, user-friendly and compatible with many models.

The latest released ADP Version 6.0 and above can be used to design applications for the HMI.

1.2 Safety Precautions

Both the installer, the owner, and the operator of this HMI must read and understand this installation manual.

General

- Only qualified personnel may install or operate the HMI.
- The HMI must be installed according to the installation instructions.
- The HMI is designed for stationary installation on a plane surface, where the following conditions are fulfilled:
 - no high explosive risks
 - no strong magnetic fields
 - no direct sunlight
 - no large, sudden temperature changes
- Never allow fluids, metal filings or wiring debris to enter any openings in the HMI. This may cause fire or electrical shock.
- The HMI fulfills the requirements of article 4 of EMC directive 89/336/EEC.
- Storing the HMI where the temperature is lower/higher than recommended in this manual can cause the LCD display liquid to congeal/ become isotopic.
- The LCD display liquid contains a powerful irritant. In case of skin contact, wash immediately with plenty of water. In case of eye contact, hold the eye open, flush with plenty of water and get medical attention.
- The supplier is not responsible for modified, altered or reconstructed equipment.
- Use only parts and accessories manufactured according to specifications of the supplier.
- Peripheral equipment must be appropriate for the application and location.
- The figures in this manual serves an illustrative purpose. Because of the many variables associated with any particular installation, the supplier cannot assume responsibility for actual use based on the figures.

- The supplier neither guarantees that the HMI is suitable for your particular application, nor assumes responsibility for your product design, installation or operation.

Power Source

- The HMI is equipped with a 24 V DC input. Supply power other than 24 V DC \pm 15% will severely damage the HMI. Thus, check the power supply supporting the DC power regularly.
- To avoid electric shock, be sure the power cable is unplugged from the power outlet when connecting the cable to the HMI.

Installation

- Communication cables must be separated from the power cables for operational circuits. Use shielded cables or it may cause unpredictable problems.

During Use

- Emergency stop and other safety functions may not be controlled from the HMI.
- Do not use force or sharp objects when touching the keys, display etc.

Service and Maintenance

- Only qualified personnel should carry out repairs.
- Before carrying out any cleaning or maintenance operations, disconnect the equipment from the electrical supply.
- Clean the display and surrounding front cover with a soft cloth and mild detergent.
- Replacing the battery incorrectly may result in explosion. Only use batteries recommended by the supplier.

Dismantling and Scrapping

- The HMI or parts thereof shall be recycled according to local regulations.
- The following components contain substances that might be hazardous to health and the environment: lithium battery, electrolytic capacitor and display.

 **Note:** Indicated loss of life, severe personal injury, or substantial property damage will result if proper precautions are not taken.

1.3 Package Contents

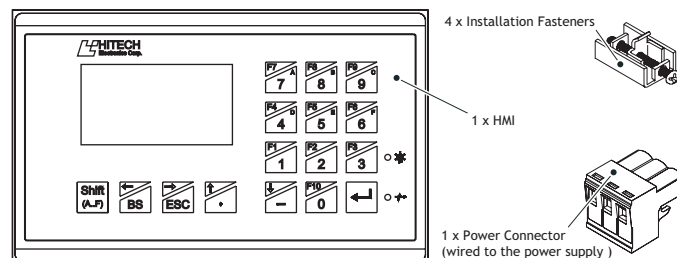

1.4 Mounting Procedure

1. Cut out the control front panel to match the dimensions (mm) specified under the External and Cut-out dimensions chapter.
2. Mount the HMI into the cut-out. Insert the fixtures to the holes on the unit and fasten the screws into the front panel. Do not tighten the screws with too much or uneven force, or it may cause deformation of the HMI.

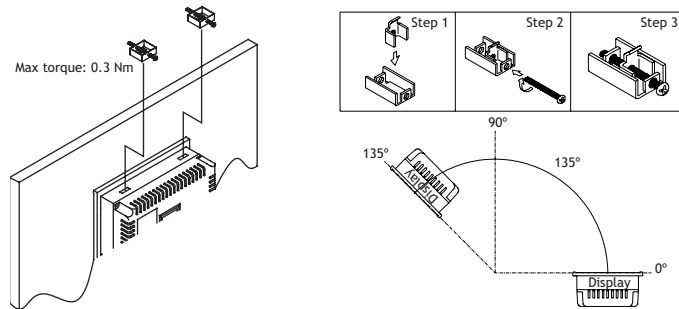

3. The HMI must be installed within an angle of 0° to 135° as shown above.

1.5 Grounding

Make sure that the HMI works properly. To prevent it from radiating radio frequency noise, the HMI must be connected to earth ground.

- Without grounding, the HMI may be severely affected by excess noise. Make sure that the grounding is done properly from the power connector at the rear side of the HMI. When power is connected, make sure that the wire is grounded.
- Use a cable of at least 2 mm² (AWG 14) to ground the HMI. Ground resistance must be less than 100 Ohms (class3). Note that the ground cable must not be connected to the same ground point as the power circuit.

1.6 Power Supply and Wiring

The HMI must use a power supply with 24 V DC and the power consumption is 8W.

Warning:

To avoid an electric shock, be sure to switch off the power before connecting the communication/download cable to the HMI.

Steps to wire

4. Unplug the power connector and unscrew the screws.
5. Strip about 1 cm of insulation. Insert the wire all the way into the power connector and then turn the screws tight.
6. Plug in the connector to the power outlet of the HMI.

Note:

Power connector is already plugged in the power outlet of the HMI when the package is first opened.

1.7 LCD Contrast Adjustment

- One can use the VR button on the back of the HMI to adjust LCD contrast (STN LCD). Use a small screwdriver to turn the VR button, clockwise = contrast down, counter-clockwise = contrast up.

1.8 External and Cut-out Dimensions

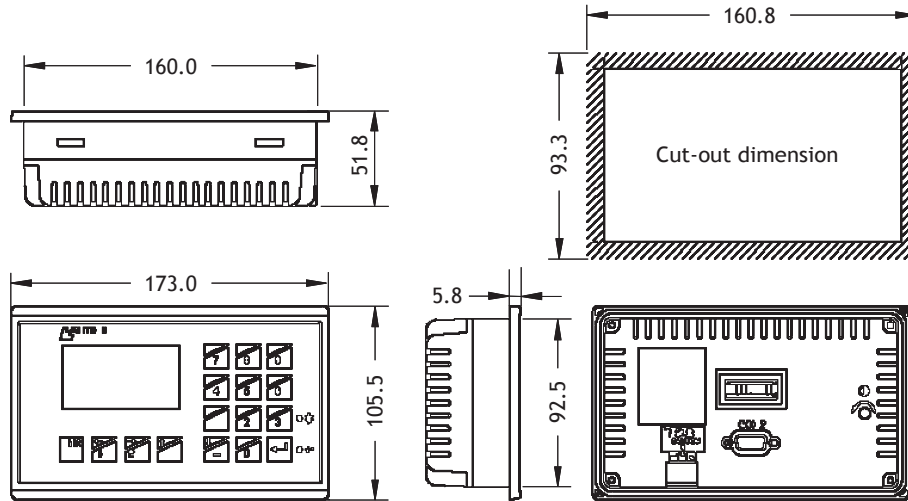

(unit: mm)

1.9 Description of Parts

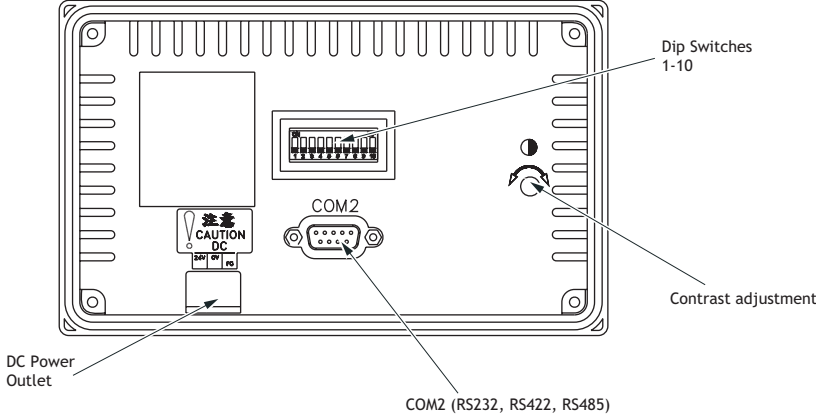
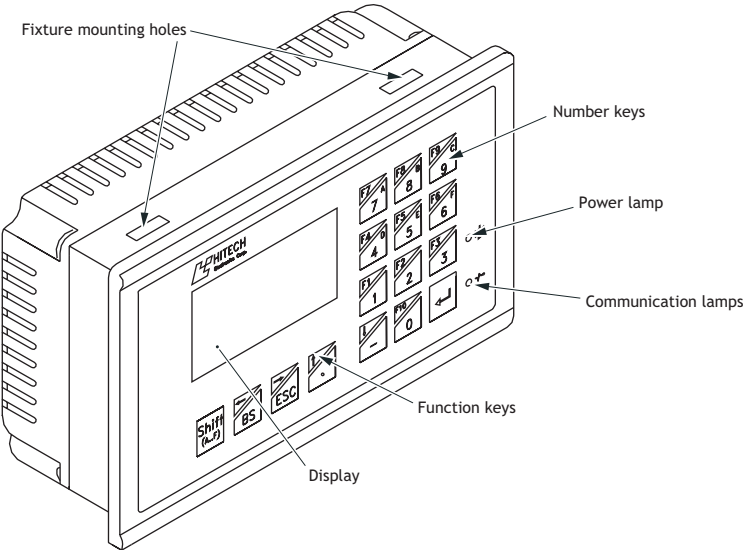

1.10 Product Specifications

Item	PWS6300
Display Type	Mono STN LCD
Display Color	Black / White, 16 grey levels
Display size	3.0" (diagonal), display area is 65x35mm
Display resolution	160x80, could display 20x10 characters of 8x8 size
Contrast Adjustment	Contrast adjustable by VR on the back
Back light	Yellow-Green LED, Life time is approx. 75,000 hours
Keypad	16 mechanical swithes, Life of each swith is over 500 thousand activations, Membrane overlay is resistant to most solvents and chemicals
Input Power	24 V DC +-15%, (or 20V-28V), under 8 W
Flash ROM	4 Mb
RAM	128 K byte
CPU	32 bits RISC
Battery backed memory	NO
RTC	YES
Communication ports	RS232/RS422/RS485
Front Panel seal	IP65 / NEMA 4
Operating temperature	0° - 50° C
Storage temperature	-10° - 60° C
Ambient humidity	20-90% (non-condensing)
Vibration endurance	0.5 mm displacement, 10-55 Hz, 2 hours per X, Y, Z axis directions
Shock endurance	10 G, 11 ms three times in each direction of X, Y, Z axes
RF Emissions	CISPR 22, Class A
Electrostatic discharge	IEC61000-4-2
RF Susceptibility	IEC61000-4-3
High Frequency Transients	IEC61000-4-4
External dimensions	173 x 105.5 x 51.79 mm
Cut-out dimensions	160.8 x 93.3mm
Weight	0.65 kg
Cooling	Natural cooling

Note:

When using the HMI for the first time, remember to reset Real Time Clock (RTC).

1.11 Communication Ports

- COM 2 is a 9-pin female connector used to connect a controller and the HMI via RS232, RS422 or RS485

Please also make sure that the connection is in accordance with the setting of Dip Switches. (For example, RS485 with SW10=ON)

For illustration on the connection between the HMI and a controller, please consult the information on the controller.

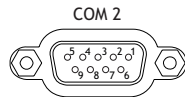

PIN	Function
1	RS422 TX+ (RS485+)
2	RS232 RXD
3	RS232 TXD
4	RS422 RX+
5	Signal ground
6	RS422 TX- (RS485-)
7	RS232 RTS
8	RS232 CTS
9	RS422 RX-

1.12 Dip Switches

Dip Switches		Function
SW 1		Reserved
SW 2		Reserved
SW 3	SW 4	Operation Mode
ON	ON	Runs user application
ON	OFF	Runs burn-in test program
OFF	ON	Updates BIOS
OFF	OFF	Runs bench test program
SW 5		Communication Parameters
ON		The HMI uses parameters defined on the Configuration Screen for controller communications
OFF		The HMI uses parameters defined in ADP for controller communications
SW 6		Password
ON		The HMI asks the operator to enter a password after power-on self-test
OFF		No password is required to start the HMI
SW 7		System Menu
ON		The HMI displays System Menu
OFF		The HMI runs user application without displaying System Menu
SW 8		Default user level
ON		The default user level is set to 1 if the HMI requires no password to start its operation
OFF		The default user level is set to 9 if the HMI requires no password to start its operation
SW 9		Reserved (no function)
SW 10		COM 2 Port
ON		For RS485 this switch has to be set ON
OFF		For RS422 this switch has to be set OFF
		For RS232, this switch has no effect

2 PWS6300 Operation

2.1 Self Test

Once the HMI is turned on, it will automatically execute a self-test to check its hardware. The result of a self-test is displayed on the LCD. See below for items to check in a self-test:

```

          BIOS Version 1.0
        (C) 2005 Hitech Beijer Elec. AB

System RAM... 128KB
Flash Memory... 4MB
Battery check.... (or x)
Parameter check... (or x)
BIOS check..... (or x)
Firmware check.... (or x)
Application check. (or x)
RTC check..... (or x)
DIP SW 8-1: 11011111 (or other combinations)

```

If any of the tests does not pass the self-test, it will be noted with a “x” mark next to the test item. Press any key to continue.

If the power to the HMI or the PC was interrupted while downloading, **Firmware checksum** or **Application checksum** will not pass the self-test, indicated by “Failed” in the self-test results after power is restored. If this happens, the user can simply follow the download procedure to re-download the application or data. After downloading again, all items should pass the self-test.

2.2 System Menu

Set the dip switch SW7=ON. After the self-test, the system menu of the HMI is displayed on the screen:

Wait command..			
Link	F7	F8	F9
	Config	Copy	Run

The functions of the commands are briefly explained below:

System Menu	Function
Link	The HMI is connected.
F7 - Config	Sets up the internal time clock and communication parameters in the HMI. All the settings has to be made for the HMI to work properly. Use ↑, ↓, ← and → to move to desired field; + and - to set the value of the field.
F8 - Copy	Copies application data to another HMI.
F9 - Run	Runs the application.

2.3 Keypad

There are 16 keys in the HMI and they can be categorized into Numerical Keys, Navigation Keys and Functional Keys.

The F1 ~ F10 keys are the Functional or Auxiliary Keys which could be defined in ADP. Please refer to ADP User's Manual for further details.

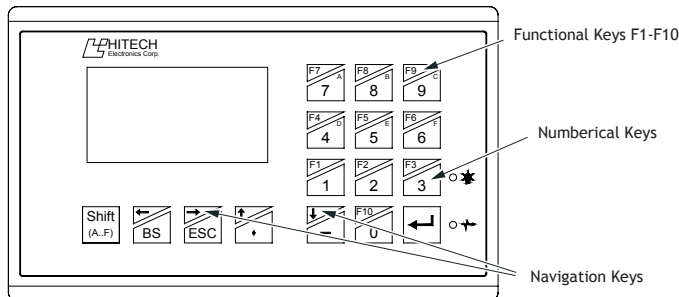

When a key is pressed, the HMI will make a “beep” sound to signal that a command is pressed. (The default setting is a 200 ms beep, and can be configured.)

2.4 Bench and Function Tests

Set the dip switches SW3 and SW4=OFF to be able to run the bench and function tests for the HMI. Turn on the HMI and the following screen will be displayed.

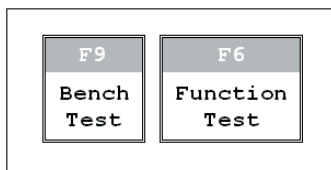

The bench test performs an overall hardware test and the function test lets the user select which item to be tested.

Note:

The bench test will clear the application data of the HMI.

2.5 Setting Communication Parameters

There are two ways to configure working parameters; to set parameters in the HMI or in ADP. To set parameters in the HMI, select F7 - **Config** in the system menu.

Note:

Remember to set the dip switch SW5=ON if parameters are set in the HMI

To set parameters in ADP, select **Application / Workstation Setup**. Then select the **Connection** tab to set communication parameters.

Note:

Remember to set the dip switch SW5=OFF if parameters are set in ADP

2.6 Downloading an Application

Connect the RS232 port on the PC to the COM1 port on the HMI using a WPC-P8-42 cable. The connection can also be made according to the illustration below.

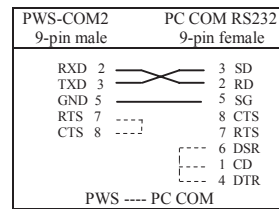

Warning:

To avoid an electronic shock, be sure to switch off the power before connecting the download cable to the HMI.

Set the dip switch **SW7 = ON**. After the self-test, the system menu will be displayed on the screen and the HMI is ready to download the application.

Start ADP and open the application file to be downloaded. Make sure that the communication parameters are correctly configured. Also remember to compile the file before downloading it. The file has to be compiled every time a change has been made in the file before downloading it.

Then select **Application/Download Firmware** and then **Application** in ADP if it is a first time to download the application to the HMI; otherwise, select **Application/Download Application**. The following appears on the screen while the HMI is downloading:



2.7 Uploading an Application

An application can also be uploaded from the HMI to the PC. Thus, a user can save an application as a *.V6F file in ADP for future use.

Warning:

To avoid an electric shock, be sure to switch off the power before connecting the communication cable to the HMI.

Make sure that the HMI and the PC are connected according to section “Downloading an Application”. Set the dip switch **SW7 = ON**. After the self-test, the system menu will be displayed on the screen and the HMI is ready to upload the application.

Also make sure that communication parameters are correctly configured. Select **File/Upload Application** in ADP and the **Save As** dialog box will appear on the screen. Enter the name of a firmware file (*.AF6) to save. Click **Save**. Then the HMI will prompt for a password: enter the password set in ADP from **Application/Workstation Setup**. Once the correct password is entered, the HMI starts to upload the application to the PC. For information about setting a password, please see section “Setting a Password”.

While the HMI is uploading, the following is displayed:



After uploading, select **File/Reconstruct Source** in ADP to display the **Open** dialog. Open the uploaded application file (*.C64 or *.AA6). The application screen will be displayed on the PC monitor. Finally, select **File/Save As** to save the application as a *.V6F file. Thus a source file can serve the purposes of maintenance and modification.

Note:

When using the HMI for the first time, make sure to first run the application once, or else the upload function will not work.

2.8 Copying an Application

To copy an application from one HMI to another, select **F8 - Copy** from the system menu. Set the dip switch **SW7 = ON** and connect the two HMIs with a download cable. After the self-test, the system menu will be displayed on the screen.

Select **F8 - Copy** in the system menu from the HMI with the application to be copied. The HMI will prompt for a password: enter the password set in ADP from **Application/Workstation Setup**. Once the correct password is entered, the HMI will start to copy the application between the two HMIs. The following appears on the screens during the copying:

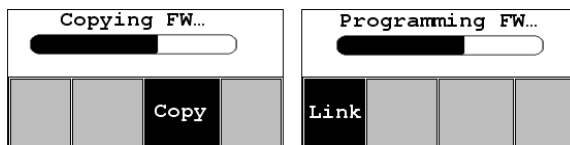

Note:

If it is the first time to copy, please remember to run the application once, or else it will not work.

2.9 Setting a Password

Scenario 1: Requiring a password to start the HMI

If the dip switch **SW6 = ON**, the user needs to enter a password to start the HMI. For this purpose, the designer can use the object **Action Button** in ADP to create a button which displays the password table on the HMI display. A user with the right to access the table can register passwords and user levels in the table. In the illustration below, the **TBL**-button is an action button used to display the password table. When the button is selected the password table is displayed on the screen for a user with the right to access the table. Use **↑ ↓ ← →** to move and **↵** to highlight an area for entering a value.

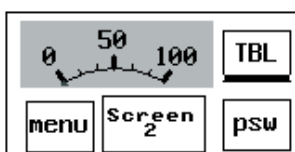

In the illustration above, the TBL-button is an action button used to display the password table. When the button is selected the password table is displayed on the screen for a user with the right to access the table. Touch the password to highlight an area for entering a value.

How to configure an **Action Button** is described in the ADP User's Manual.

After registering passwords and user levels, set the dip switch SW6 = ON (i.e. password required). Restart the HMI and after the self-test the user will be prompted to enter a password in order to run the HMI. The HMI will determine the user level from the entered password. For instance, if the level of the password entered by the user is 2, then the HMI will set the user level to 2. User level 1 has the highest privilege and User level 9 has the lowest.

Note:

Only users of User Level 1 has the right of access to the password table.

Scenario 2: Re-entering a password

The object **Action Button** in ADP also allows the designer to create a button which asks the user to re-enter a password. For example, by pressing the **PSW**-button the password keypad will be displayed to prompt the user to enter a password. After entering the password, the HMI will update the user level according to the most recent password which has been entered. Therefore, this button can be applied to raise or drop one's privileges while the HMI is in operation.

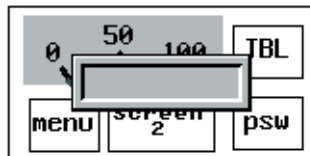

How to configure an **Action Button** is described in the ADP User's Manual.

Scenario 3: Password-protecting a button in the HMI

The ADP can create a button which is protected by a password for execution. For example, a **Goto Screen** button can be designed with a high level of security; which means that a password with a high level of privilege is required in order to open the other screen. As the button is selected and the current user has a lower privilege than has been set for the button, the HMI will prompt the user for a password. The user will need a password with at least the level of privilege that has been set for the button. This function can restrict users to access to certain parts of the application.

Scenario 4: Requiring a password to copy or upload application

When selecting **F8 - Copy** in the system menu or **File/Upload Application** in ADP, the HMI will prompt for a password. The user will need to enter the correct password to copy an application from one HMI to another. Note that setting this password is different from the passwords set in Scenarios 1-3. To set this password, select **Application/Workstation Setup** in ADP. Under the **Password** tab, the project designer is able to set the password.



- a Beijer Electronics Group company

Hitech Electronics Corp.
4F, No. 501-15, Chung-Cheng Road
Shin-Tien, Taipei Shien, Taiwan, R.O.C.
Telephone: +886-2-2218-3600
Telefax: +886-2-2218-9547